

VEKTOR 1100 SPACE HEATER

INSTALLATION & OPERATING MANUAL

The Vektor space heater is suitable to be installed into a frame out installation. Designed to operate on Natural gas

Approval no. GMK 10622

VERSION 2

WARRANTY INFORMATION

The benefits provided to you under the following warranty are in addition to any other rights and remedies available to you under the law.

1. Warranty

If:

- (a) during the first 15 years from the date of purchase (Firebox Warranty Period), there is a defect in the firebox of the Gas Burner; or
- (b) during the first 2 years from the date of purchase (Parts Warranty Period), there is a defect in the gas valves or other parts of the Gas Burner,
due to improper workmanship or material, Glen Dimplex will replace or repair the Gas Burner without charge. Any replacement product is warranted only for the time remaining on the original Firebox Warranty Period or the Parts Warranty Period as relevant.

2. Registration

You must register to receive the benefit of this warranty by completing the warranty registration on our website (www.realflame.com.au) or completing and mailing the attached registration card within 30 days of purchase of your Gas Burner (or, if the Gas Burner is fitted to a new home, within 30 days of the date of settlement of purchase of such new home).

3. Exclusions

Glen Dimplex is not obliged to replace or repair the Gas Burner under clause 1 if:

- (a) it has been improperly stored, installed, connected, used, operated or repaired, or damaged, abused, tampered with, altered (without our written approval), or not maintained in strict accordance with our installation and operating instructions; or
- (b) it has been installed in an outdoor setting.

4. Limit of Liability

The warranty provided under this warranty is limited to replacement or repair of the Gas Burner only, at our option. To the extent permitted by law, Glen Dimplex excludes liability for consequential loss or any other loss or damage caused to property or persons arising from any cause whatsoever, and damage arising from normal wear and tear.

5. Claiming under the Warranty

In order to claim under this warranty you must, within the Firebox Warranty Period or the Parts Warranty Period (as relevant), contact Glen Dimplex, providing the original proof of purchase and the details below:

Supplier Name _____

Date Of Purchase / settlement of property if new home _____

Model / Serial Number _____

This warranty does not cover the cost of claiming under the warranty or transporting the Real Flame Gas Burner to and from the supplier.

Our goods come with guarantees that cannot be excluded under the Australian Consumer Law. You are entitled to a replacement or refund for a major failure and for compensation for any other reasonably foreseeable loss or damage. You are also entitled to have the goods repaired or replaced if the goods fail to be of acceptable quality and the failure does not amount to a major failure.

If you would like to speak to someone about your Gas Burner or claiming under this warranty, please contact the Service Warranty Desk on 1300 554 155.

Glen Dimplex Australia Pty Ltd ACN 69 118 275 460
Head Office: 1340 Ferntree Gully Road, Scoresby 3179
Telephone: (03) 8706 2000 Facsimile: (03) 876 2001

WARNING

The Vektor space heater has a primary safety glass fitted in front of the glass door. This safety glass is fitted to this appliance to reduce the risk of injury from burns and at no time should this glass be permanently removed. For protection of young children or the infirm, a secondary guard is required.

The appliance is not intended for use by persons (including children) with reduced physical, sensory or mental capabilities, or lack of experience and knowledge, unless they have been given supervision or instruction concerning use of the appliance by a person responsible for their safety. Children should be supervised to ensure that they do not play with the appliance.

WARNING

The glass panel gets extremely hot! Precaution should be taken and young children supervised at all times when heater is operating.

INSTALLATION NOTICE

- The installation of this appliance is only to be carried out by an authorised person in accordance with the Manufacturer's Instructions, local gas fitting regulations, AS/NZS5601.1-2013 installation code for gas burning appliances and any other relevant statutory regulations.
- In all cases the installation of this appliance shall meet the requirements as set out in AS/NZS5601.1-2013.
- Do not install in a fireplace as a Type 1 installation.
- Not intended as a fireplace insert

- NOTE: A slight smell may be apparent for the first few hours of use. This is due to the heat resistant paint curing. It is recommended to open windows in the room for the first lighting of the fire. In some instances a slight discolouration may occur inside the firebox. This is a normal condition and is not covered by warranty.

IMPORTANT SAFETY NOTICE

- DO NOT PLACE ARTICLES ON OR AGAINST THIS APPLIANCE.
- DO NOT USE OR STORE FLAMMABLE MATERIALS IN OR NEAR THIS APPLIANCE.
- DO NOT SPRAY AEROSOLS IN THE VICINITY OF THIS APPLIANCE WHILST IT IS IN OPERATION.
- CARE MUST BE TAKEN TO ENSURE THAT ANY RETURN AIR REGISTER OR EXHAUST SYSTEM DOES NOT ADVERSLEY AFFECT THE OPERATION OF THE APPLIANCE OR DRAUGHT OF CHIMNEY OR FLUE.
- DO NOT MODIFY THIS APPLIANCE.
- APPLIANCE IS DESIGNED TO OPERATE WITH LUMINOUS FLAMES. MAY EXHIBIT SLIGHT CARBON DEPOSIT.

SERVICING

It is recommended you service your gas fire every 2 years as a minimum.

CORD REPLACEMENT

Electrical cord replacement must be undertaken by qualified and trained personnel only.

CONTENTS

Contents	4
Dataplate	5
Dimensions.....	6
Installation Instructions	7
Timber Frame Installation	9
Flue Termination	10
Installation Instructions (continued)	11
Commissioning procedure	25
Door removal and fitment	26
Media Installation.....	28
Media Setup.....	29
LED Lighting	32
Operation - User Instructions.....	33
Remote Control Operating Guide	34
Wifi Device Control Instructions.....	37
Troubleshooting	44
Burner Pressure Adjustment.....	45
Wiring Diagram	46
Injector And Pilot Removal Instructions	47
Parts List.....	52
Glen Dimplex contact information.....	56

DATA PLATE (Affixed to the base of the unit for reference to gas pressure & consumption)

Vektor Heater

GAS TYPE	INJECTOR SIZE	TPP	N.G.C. (Mj/hr)
Natural Gas	1 X 1.85mm; 4 X 1.70	0.62kPa High / 0.45kPa Low	46 High/41 Low

Max - Min inlet pressure range

Natural gas 1.13kPa – 5.00kPa

Aeration settings

Media setup	NAT GAS
Campfire Media	7.5mm

Burner Assembly

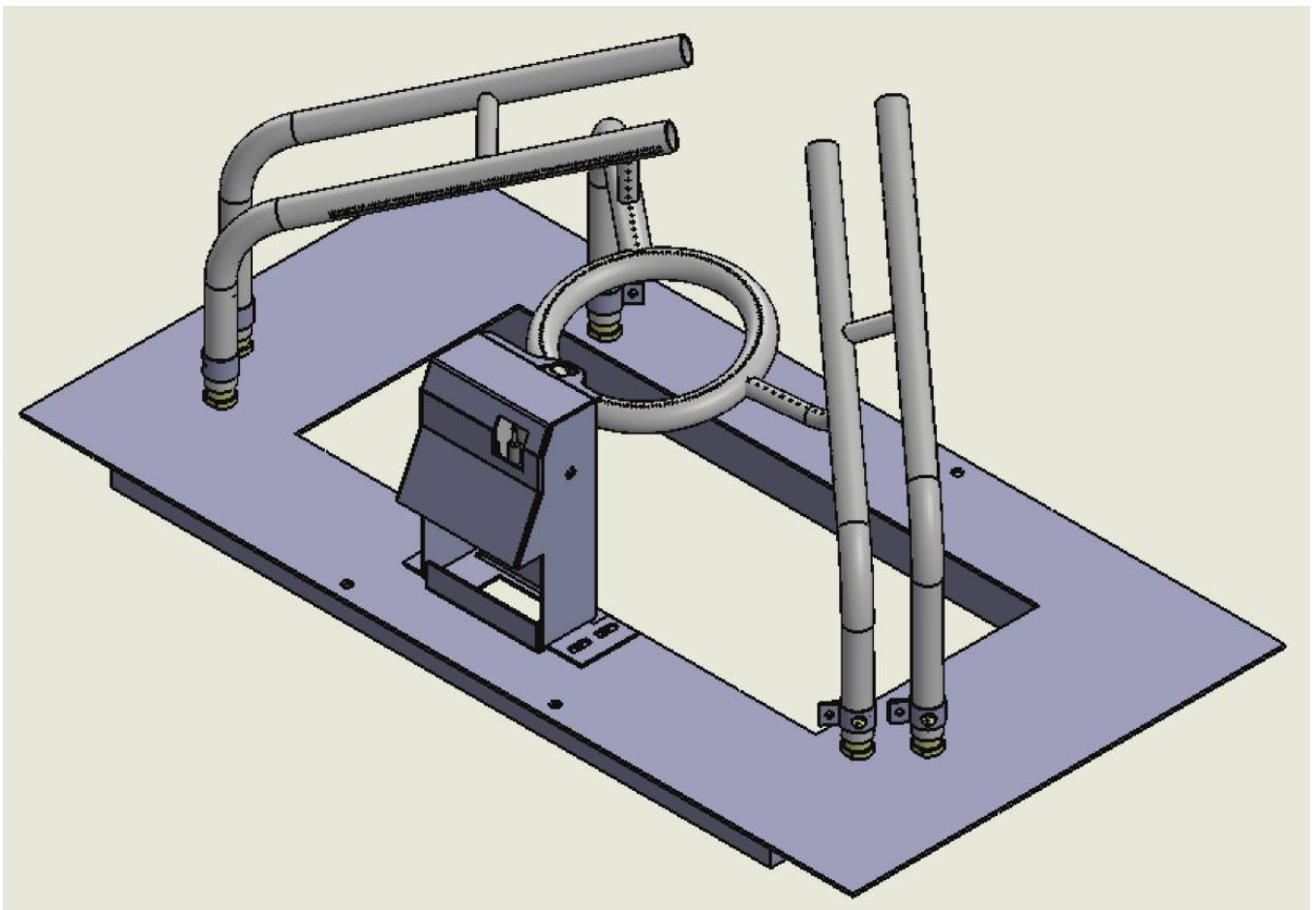

DIMENSIONS

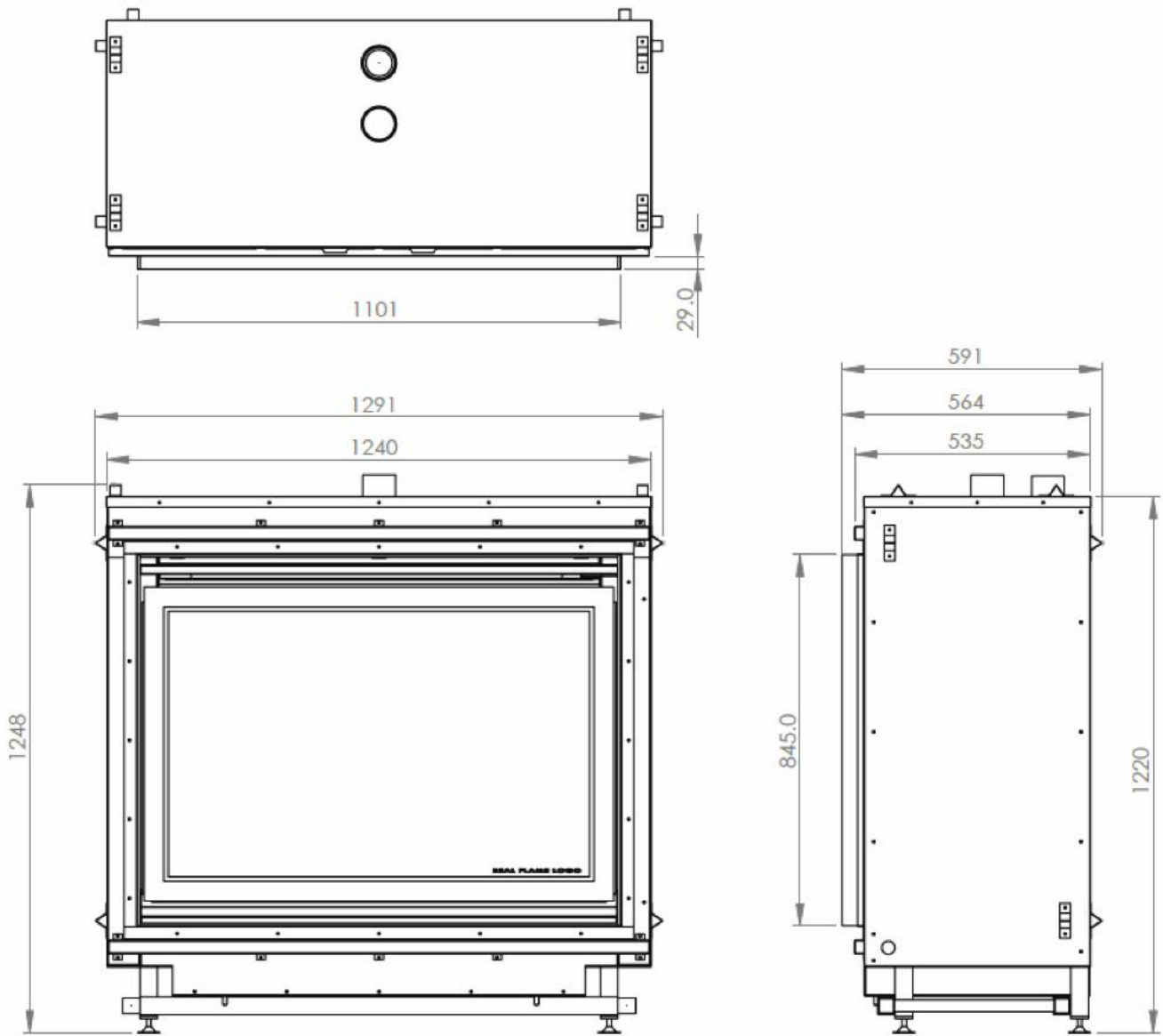

FLUE CONNECTIONS

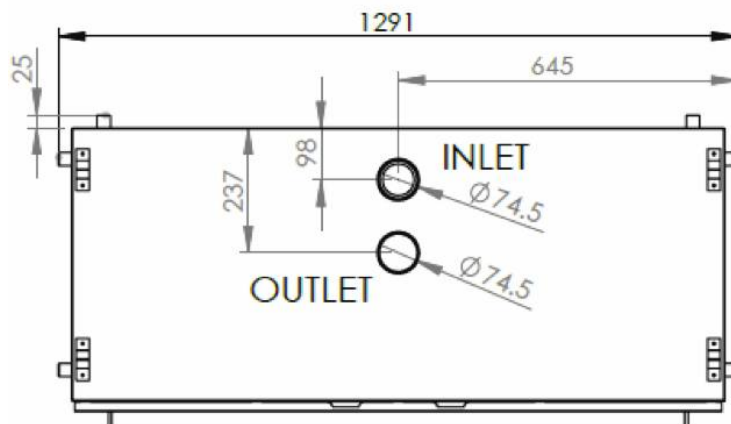

INSTALLATION INSTRUCTIONS

LOCATION

Select a location where the fire can be supervised during operation.

An electrical isolation switch must be fitted at the appliance or on an adjacent wall to allow for emergency shutdown and maintenance.

Installation must meet Australian gas codes AS5601.1-2013.

Installation clearances - Clearances from combustible materials

Floor	0mm
Above top trim (mantle installations)	25mm
Ends	25mm
Top	25mm
Flue Outer	50mm
Rear	25mm
Front	25mm (0mm on plaster channel)

NOTE

Once installed no combustible items should be placed within 600mm of the fire viewing window.

GAS CONNECTION – 15mm (1/2”) Compression union

ELECTRICAL CONNECTION – 3 Pin 10 Amp GPO plug

POWER RATING OF APPLIANCE – 230V 50Hz 0.92 Amp

INSTALLATION CODES

Note appliance gas type – Natural gas. Should the appliance be the incorrect gas type, please contact the supplier.

Installers – Please ensure the installation and instruction manuals supplied with this appliance are supplied to the customer and the customer is trained on how to operate the appliance correctly.

Do not modify the appliance.

Do not exceed maximum rated pressures.

Appliance must be installed with gas installation code (AS/NZS5601.1-2013) and applicable electrical installation code (AS3000).

Test for gas leaks prior to operating appliance.

Check gas pressures and adjust if incorrect.

FLUE CONFIGURATIONS

Flue configurations 5m or less run an aluminium flexible flue for both the inlet and outlet. Where lengths greater than 5m are required a poly flue system is used, refer to the manufacturer XLC flue configurations manual.

Recommended Silicon – Non acetic, neutral cure 150degc or higher temperature rated.

Bostik RTV 926 or similar

U style flue runs must not be installed

FLUE SPECIFICATIONS

75mm internal diameter twin walled aluminium flexible flue, supplied in 5m lengths.

Flue external diameter approx. 83mm.

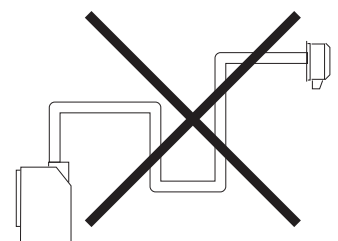

INSTALLATION INSTRUCTIONS (continued)

Flue runs 0m to 5m length (excluding 0-5m rooftop termination)

- External wall mount outlet with integrated flue fan (XL model)
- External wall mount terminal (Flue fan installed above appliance internally)(XL model)

Flue runs 0m to 5m length rooftop termination only

- Vertical roof termination (S/Steel rooftop termination)

FLUE TERMINATION LOCATIONS

This section is used to determine where your Balanced Flue termination will be located.

- Flue terminations shall not be recessed in walls or sidings.
- **EXTREMELY IMPORTANT:** In heavy snow areas take extra care to prevent blocking flue termination with snow removal equipment.
- Flue gases exiting flue terminals are very hot and must not be restricted to assure fireplace combustion is not affected.
- Do not place, build any obstruction, plant any bushes or for any reason attempt to conceal the flue termination. To do so will affect the operation of the fireplace and may be hazardous.
- This unit must always vent directly to outdoors.
- External terminations may not be suitable in snow/ice conditions.
- Condensing models are not suitable in snow/ice conditions - refer Glen Dimplex for advice.

TIMBER FRAME INSTALLATION

5mm Flat Steel Trim

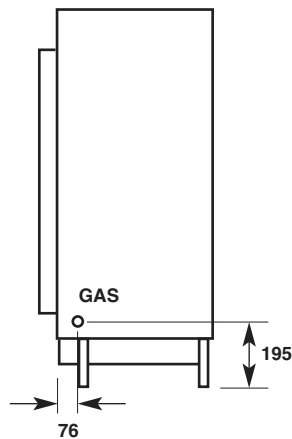
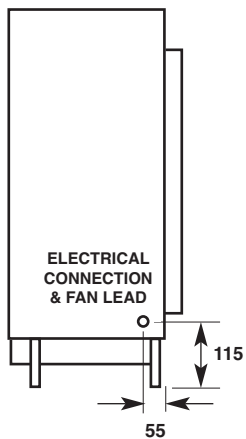
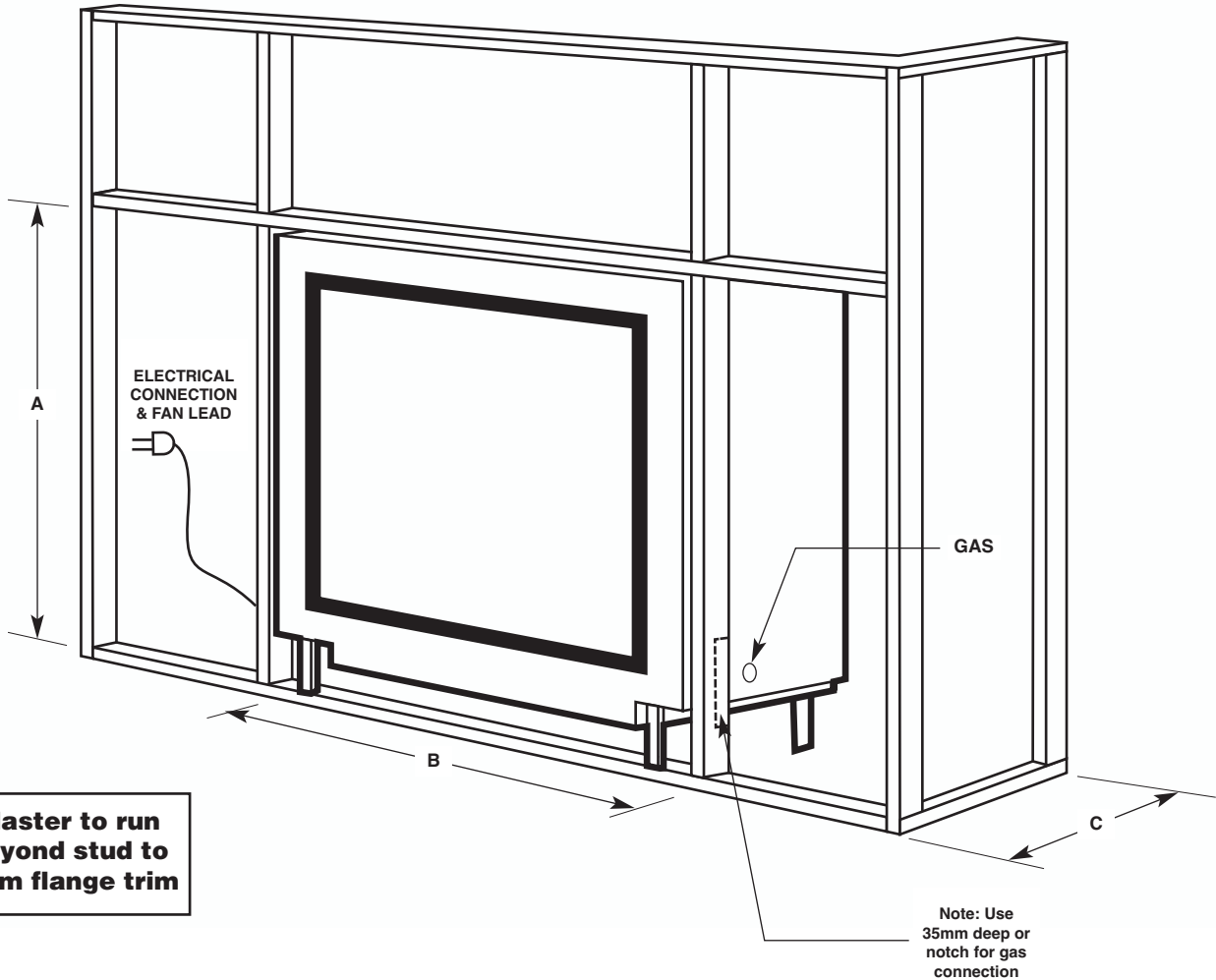

Frameout Dimensions (in mm)

Model	A	B	C	D
Vektor	1300	1450	600	mm less plaster thickness each side TBA

FLUE TERMINATION

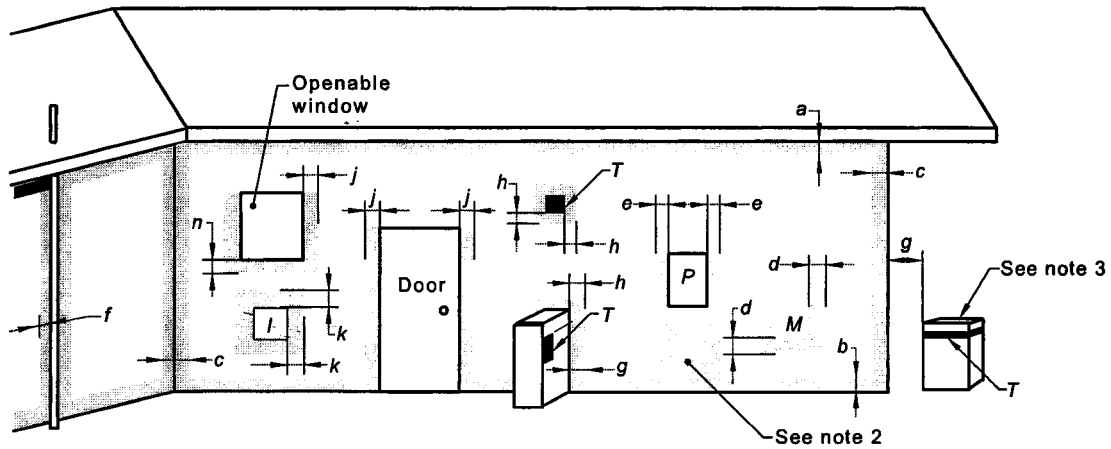

LEGEND:

- T* = Flue terminal
- I* = Mechanical air inlet
- M* = Gas meter
- P* = Electricity meter or fuse box
- Shading indicates prohibited areas for flue terminals

Ref.	Item	Minimum clearances (mm)	
		Natural draft	Fan assisted
a	Below eaves, balconies and other projections:		
	• Appliances up to 50 MJ/h input	300	200
	• Appliances over 50 MJ/h input	500	300
b	From the ground, above a balcony or other surface †	300	300
c	From a return wall or external corner †	500	300
d	From a gas meter (<i>M</i>) (see 4.7.11 for vent terminal location of regulator)	1000	1000
e	From an electricity meter or fuse box (<i>P</i>)	500	500
f	From a drain pipe or soil pipe	150	75
g	Horizontally from any building structure † or obstruction facing a terminal	500	500
h	From any other flue terminal, cowl, or combustion air intake †	500	300
j	Horizontally from an openable window, door, non-mechanical air inlet, or any other opening into a building with the exception of sub-floor ventilation:		
	• Appliances up to 150 MJ/h input	500	300
	• Appliances over 150 MJ/h input up to 200 MJ/h input	1500	300
	• Appliances over 200 MJ/h input up to 250 MJ/h input †	1500	500
	• Appliances over 250 MJ/h input †	1500	1500
	• All fan-assisted flue appliances, in the direction of discharge	-	1500
k	From a mechanical air inlet, including a spa blower	1500	1000
n	Vertically below an openable window, non-mechanical air inlet, or any other opening into a building with the exception of sub-floor ventilation:		
	• Space heaters up to 50 MJ/h input	150	150
	• Other appliances up to 50 MJ/h input	500	500
	• Appliances over 50 MJ/h input and up to 150 MJ/h input	1000	1000
	• Appliances over 150 MJ/h input	1500	1500

† Unless appliance is certified for closer installation

NOTES:

- 1 All distances are measured to the nearest part of the terminal.
- 2 Prohibited area below electricity meter or fuse box extends to ground level.
- 3 See Clause 5.13.6.6 for restrictions on a flue terminal under a covered area.
- 4 See Appendix J, Figures J2(a) and J3(a), for clearances required from a flue terminal to an LP Gas cylinder. A flue terminal is considered to be a source of ignition.
- 5 For appliances not addressed above acceptance should be obtained from the technical regulator

INSTALLATION INSTRUCTIONS (continued)

EXTERNAL WALL MOUNTED FAN MODULE INSTALLATION

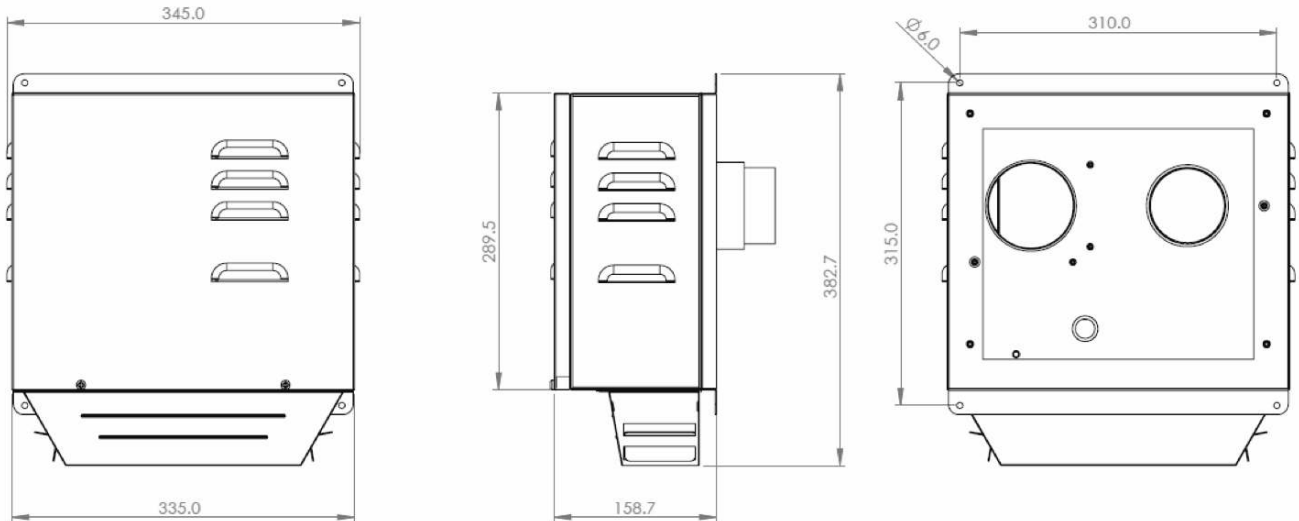

1. Wall mounted fan module – terminal must be installed with clearances as specified by AS5601.1 Clause 6.9.3
2. Run exhaust flue and air intake flue as required – Maximum run 5m. Flues can be run next to each other. Maintain clearances to combustibles.
3. Connection to appliance



Cut tube to length where required.

Ensure ends are burr free and round, test fit flue will slide over connection.

INSTALLATION INSTRUCTIONS (continued)



Recommended Silicon – Non-acetic, neutral cure 150°C or higher temperature rated.

Bostik RTV 926 or similar.

Apply an 8mm thick silicon bead fully around heater connection approx. 10mm from the top.



Apply an 8mm silicon bead fully around the inside of the flue end (heater connection end)

Fit flue clamp over flue (loosely).



Slide flue onto connection spigot fully.

Tighten clamp fully.

Wipe excess silicon, visually check connection to ensure connection is fully sealed.

4. Repeat above with air intake flue pipe to heater connection.
5. Clip flues as required to provide adequate support.
6. Connection to wall mounted fan terminal

INSTALLATION INSTRUCTIONS (continued)



Remove cover from fan terminal



Cut flue exhaust tube (hot tube) to length (Approximately flush with wall exit).

Connection plate will sit against wall. Cut Air intake flue.

Ensure ends are burr free and round, test fit flue will slide over connection.

Pull flue through approx. 100mm (will be pushed back once terminal is fitted).



Feed power cable through wall and into wall terminal.



Apply an 8mm silicon bead fully around the inside of the flue end (heater connection end)

Fit flue clamp over flue (loosely).

INSTALLATION INSTRUCTIONS (continued)

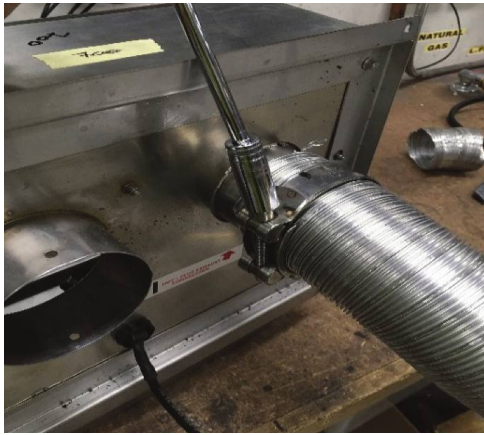

Slide flue onto connection spigot fully.
Tighten clamp fully.

Wipe excess silicon, visually check connection to ensure connection is fully sealed.



Feed air intake flue pipe through location spigot and fit retaining screw.



Push fan terminal into position. And affix to wall.
Uneven or rough surfaces may require sealant along top and side gaps.

Connect power cable connector. Fit cable clamp to cable.

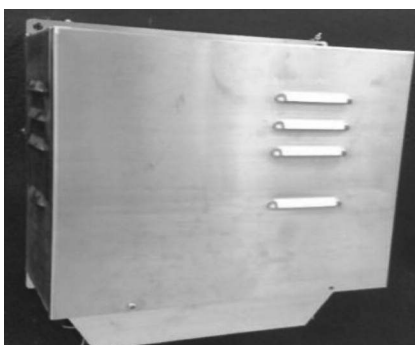

Fit front cover.

INSTALLATION INSTRUCTIONS (continued)

0M - 5M FLUE – INLINE FAN MODULE WITH WALL TERMINATION

SETUP WITH INTERNAL FAN MODULE WITH WALL TERMINATION – MID FLUE MOUNTED

Maximum 5m flue length

Wall termination

1. Wall terminal must be installed with clearances as specified by AS5601.1-2013 Clause 6.9.3
2. Run exhaust flue and air intake flue as required – Maximum total run 3m per flue. Flues can be run next to each other. Maintain clearances to combustibles.
3. Mount fan controller in the required location. (Access to the fan module is required for servicing, if the fan module is located inside a boxed frame, allow a 450 x 450 access panel).

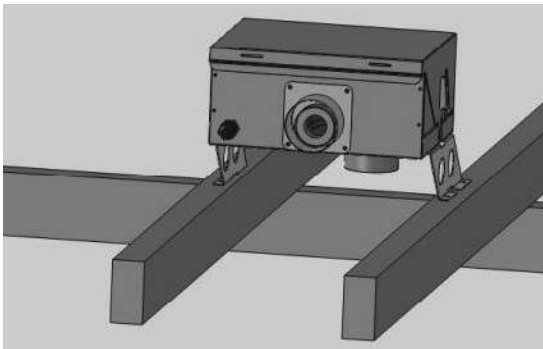

4. Connection to fan module to appliance
Run flue from appliance to bottom entry on fan module.
Support flue with brackets as required.

INSTALLATION INSTRUCTIONS (continued)



Cut flue to length to suit connection.
Ensure ends are burr free and round, test fit flue will fit over connection.



Apply an 8mm thick silicon bead fully around heater connection approx. 10mm from the top.



Apply an 8mm silicon bead fully around the inside of the flue end (heater connection end)
Fit flue clamp over flue (loosely).



Slide flue onto connection spigot fully.
Tighten clamp fully.
Wipe excess silicon, visually check connection to ensure connection is fully sealed.

INSTALLATION INSTRUCTIONS (continued)

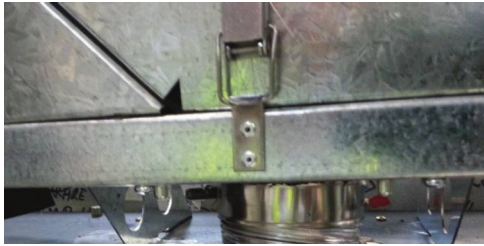

Repeat for connection to underside of fan module.



Repeat for Air intake flue connection.



5. Fan module outlet connection

Cut tube to length where required.

Ensure ends are burr free and round, test fit flue will slide over connection.



Apply an 8mm thick silicon bead fully around heater connection approx. 10mm from the top.
Apply an 8mm silicon bead fully around the inside of the flue end (heater connection end)
Fit flue clamp over flue (loosely).

INSTALLATION INSTRUCTIONS (continued)

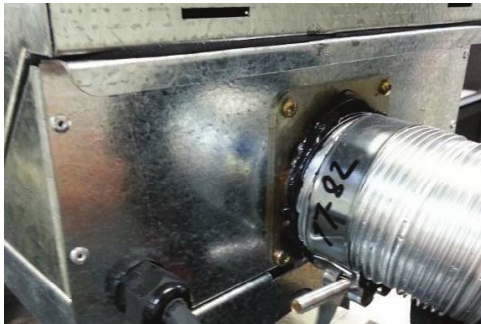

- Slide flue onto connection spigot fully.
- Tighten clamp fully.
- Wipe excess silicon, visually check connection to ensure connection is fully sealed.



6. Connect power lead to fan module. Ensure lead is clipped to support where required.
- Do not use connection to support lead.

LOOSE FIT CONNECTIONS (Wall termination connections)

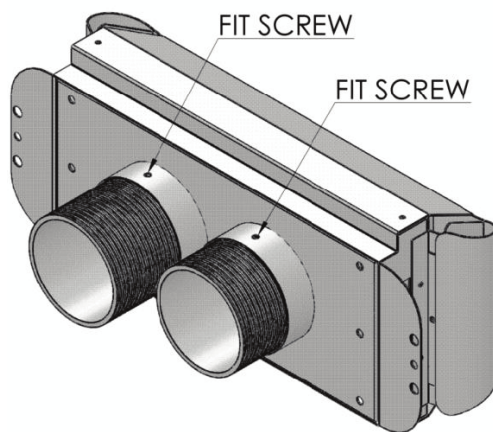

7. Connection to wall terminal

INSTALLATION INSTRUCTIONS (continued)

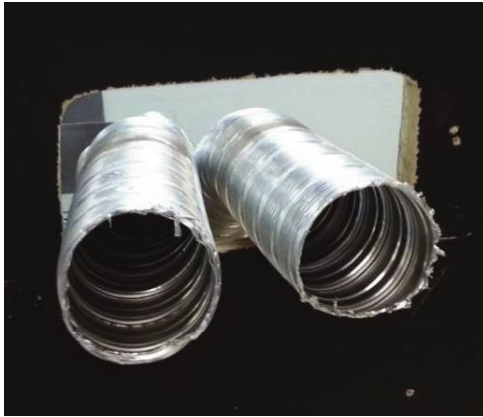

Locate terminal on wall and predrill mounting holes where required.

Cut flue exhaust tube (hot tube) to length (Flue must extend a minimum of 50mm past the exit face of wall.) It is recommended that the tubes are cut slightly longer and pushed back into wall upon fixing of wall terminal. Allow flue movement between terminal and last flue hanging clip.

Cut Air intake as per flue exhaust.

Ensure ends are burr free and round, test fit flue will slide inside both the hot exhaust connection and air intake connection.



Feed air hot exhaust flue into connection, ensure inserted 50mm. Fit retaining screw from below.



Feed air intake flue into connection, ensure inserted 50mm. Fit retaining screw from below.

INSTALLATION INSTRUCTIONS (continued)

INTERNAL INLINE FAN MODULE WITH ROOFTOP TERMINATION – MID FLUE MOUNTED

Maximum 5m flue length

Note – fan module can be appliance mounted or mid mounted when finishing with the rooftop termination.

1. Rooftop termination must be installed with clearances as specified by AS5601.1-2013.
2. Run exhaust flue and air intake flue as required – Maximum total run 5m per flue. Flues can be run next to each other. Maintain clearances to combustibles.
3. Mount fan controller in the required location. (Access to the fan module is required for servicing, if the fan module is located inside a boxed frame, allow a 450 x 450 access panel).

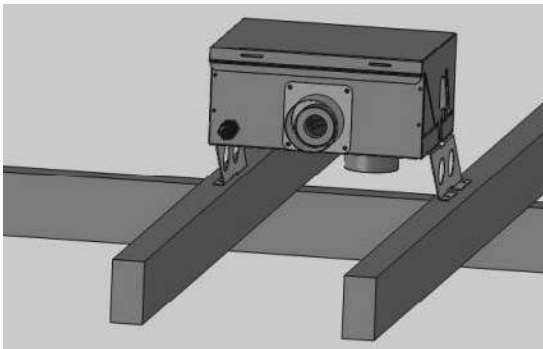

INSTALLATION INSTRUCTIONS (continued)



4. Connection to fan module to appliance

Run flue from appliance to bottom entry on fan module.

Support flue with brackets as required Cut flue to length to suit connection.

Ensure ends are burr free and round, test fit flue will fit over connection.



Apply an 8mm thick silicon bead fully around heater connection approx. 10mm from the top.



Apply an 8mm silicon bead fully around the inside of the flue end (heater connection end)

Fit flue clamp over flue (loosely).



Slide flue onto connection spigot fully.

Tighten clamp fully.

Wipe excess silicon, visually check connection to ensure connection is fully sealed.

INSTALLATION INSTRUCTIONS (continued)



Repeat for connection to underside of fan module.



Repeat for Air intake flue connection.



5. Fan module outlet connection

Cut tube to length where required.

Ensure ends are burr free and round, test fit flue will slide over connection.



Apply an 8mm thick silicon bead fully around heater connection approx. 10mm from the top.
Apply an 8mm silicon bead fully around the inside of the flue end (heater connection end)
Fit flue clamp over flue (loosely).

INSTALLATION INSTRUCTIONS (continued)

Slide flue onto connection spigot fully.

Tighten clamp fully.

Wipe excess silicon, visually check connection to ensure connection is fully sealed.

6. Connect power lead to fan module. Ensure lead is clipped to support where required.

Do not use connection to support lead.



7. Connection to rooftop terminal

Prepare roof penetration. Remove cowl from termination if fitted.



Cut rooftop penetration to length if required. Install into roof penetration. Install supports for base of penetration kit.



Connect hot exhaust flue and air intake flue as per below.

Apply an 8mm silicon bead fully around the inside of the flue end.

Fit flue clamp over flue (loosely).

INSTALLATION INSTRUCTIONS (continued)

Fit flue clamp over flue (loosely).

Slide flue onto connection spigot fully.

Tighten clamp fully.

Wipe excess silicon, visually check connection to ensure connection is fully sealed.

Fit roof sealing method. (Decktite or similar.)

IMPORTANT - Apply silicon bead between inner connection of cowl and flue pipe to seal inner flue to cowl. Outer does not require sealing.

Screw or rivet in 3 places to hold in place.



Ensure flue is supported and clipped where required.

COMMISSIONING PROCEDURE

Once the fire is installed:

- Check for gas leaks.
- Install media.
- Connect the powerflue module loom to fan control unit.
- Check flue connections are correctly fitted.
- Fit door.
- Fit outer glass.
- Carry out the lighting procedure.
- Check burner pressures and adjust as per Dataplate.
- Fit access cover and trim.
- Ensure lower access panel covers are fitted
- Check for correct combustion / operation
- Check for Co leakage
- Handover instructions to owner.
- Instruct owner on how to operate the fireplace safely.
- Instruct owner how to isolate appliance in an emergency.

DOOR REMOVAL AND FITMENT

DOOR REMOVAL (RECOMMENDED 2 PERSONS)

NOTE – It is recommended that eye protection is worn when handling glass.

- Remove front glass. - Primary guard (Use suction cups provided) Swing bottom of glass outwards, Lift up to unhook the front glass. Lift out the glass panel. Glass panels is heavy and requires 2 persons to remove.
- Place carefully on a protected surface along its entire bottom.
- WARNING - DO NOT KNOCK THE GLASS CORNERS OR EDGES
- DO NOT PLACE CORNER OF GLASS DOWN FIRST – GLASS MAY CHIP OR BREAK IF HANDLED INCORRECTLY.

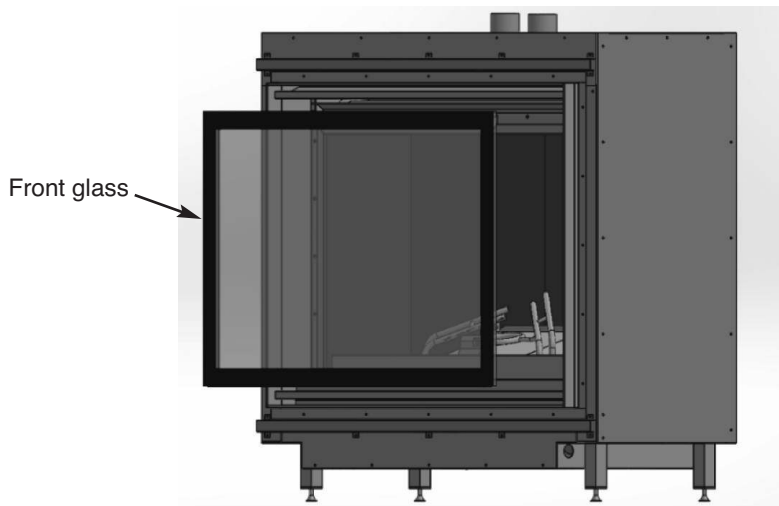

- Remove screws and remove inner door (Use suction cups provided)

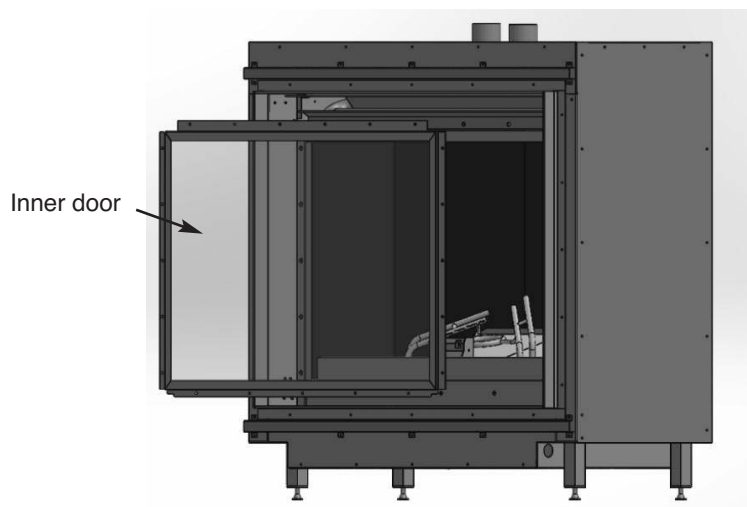

- Lift door out supporting the glass and frame together. Store carefully.
- Ensure door is supported when moving as glass may fall from frame if not fully supported. Door glass is only bonded to frame around the lower section of glass and frame.

DOOR REMOVAL AND FITMENT (continued)

DOOR FITMENT (RECOMMENDED 2 PERSONS)

- Check door glass and seal is sitting in frame correctly Door rope should be sitting around the glass perimeter. The glass with door rope sits flush in the frame.

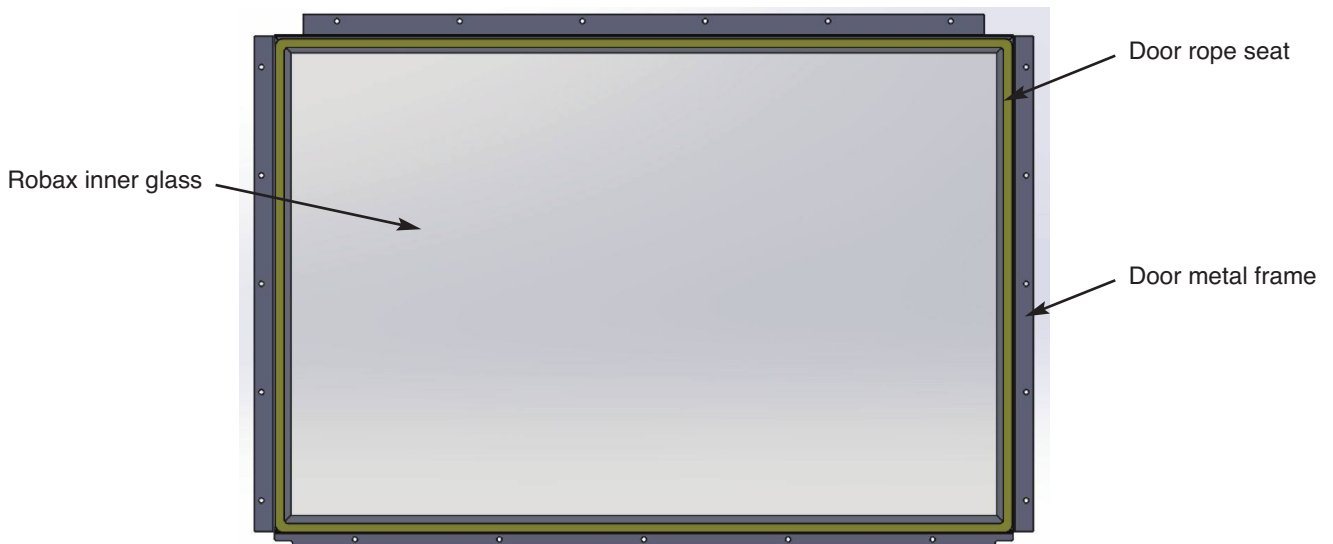

- Lift door carefully, supporting both the glass and frame. Hold vertically and gently lower down onto the lower support bracket.

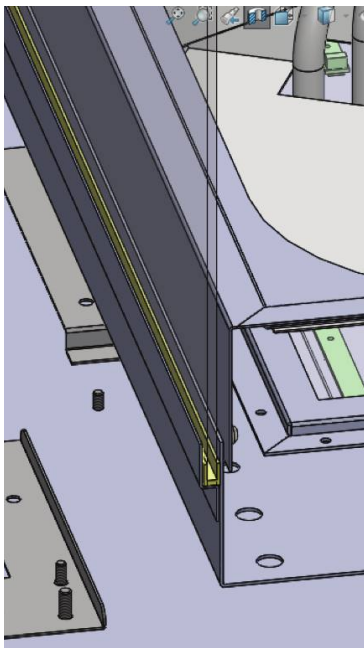

- Tilt door back and check all bolt holes line up. Slide door sideways to correct where required. DOOR MUST BE SUPPORTED AT ALL TIMES.
- Fit all screws loosely. Once all fitted hand tighten. Do not overtighten screws.

MEDIA INSTALLATION

Campfire media, clear pebbles and small ceramic coals

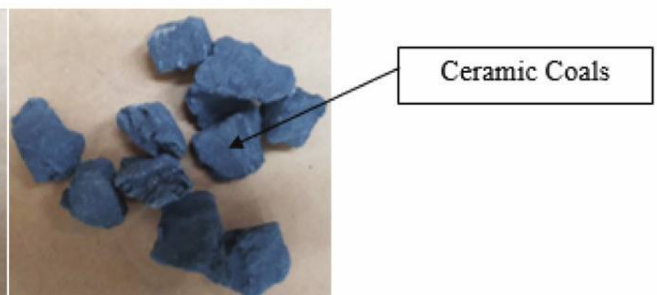
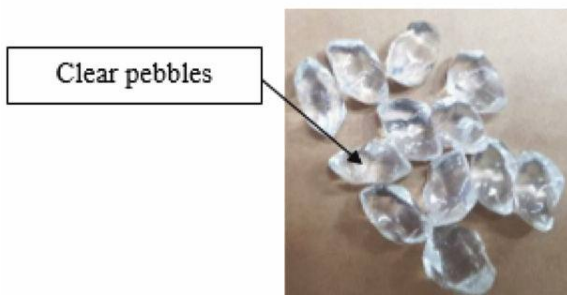
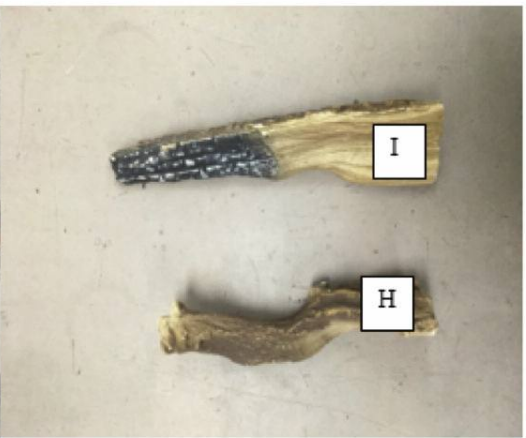
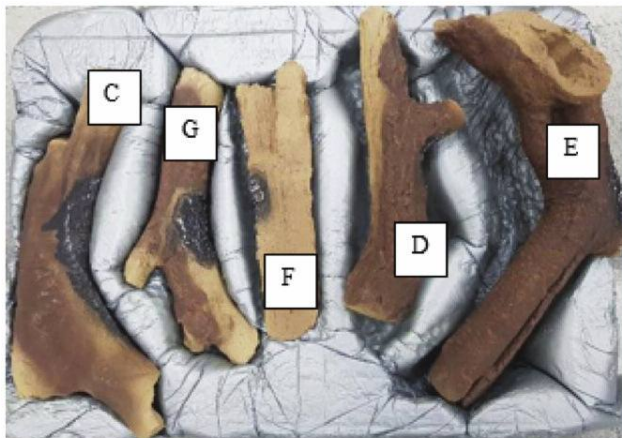
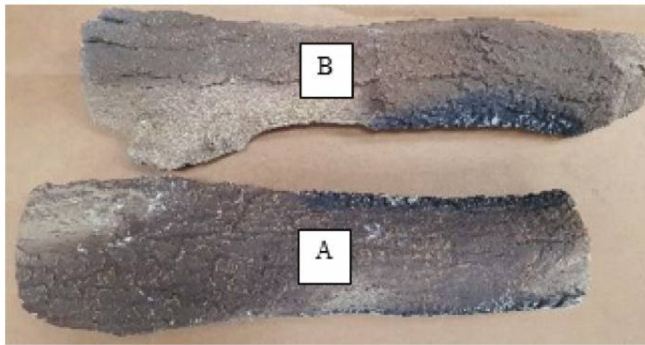
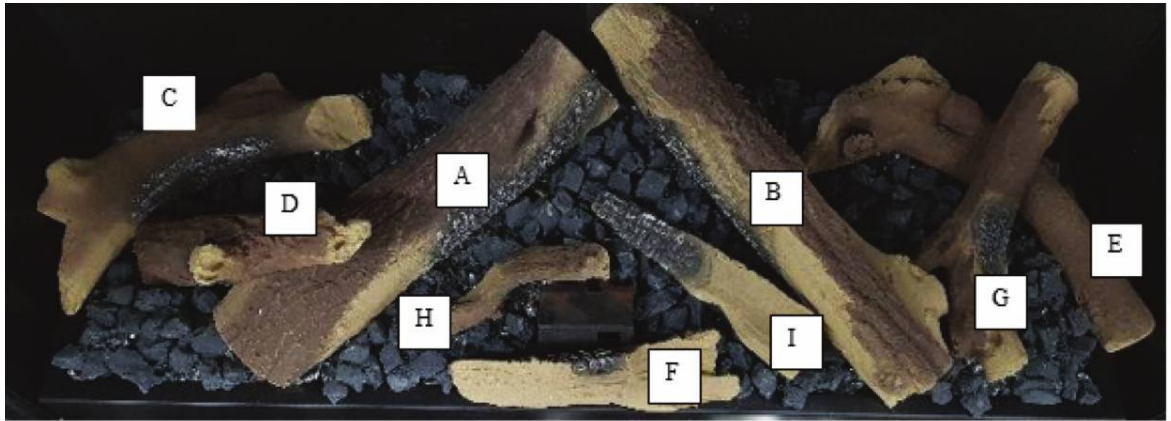

MEDIA SET UP

- Lay campfire media as per the fix arrangement shown in the image above.
- Avoid smothering the firing ports.
- Do not add extra media, or combine media types.
- Do not cover pilot area.
- Do not overfill with media above the pilot cover level.
- Remove any media that is blocking the pilot area
- Ensure the pilot flame is not impinged by media and can cross light the main burner.
- Do not use any other media than as supplied and recommended by the manufacturer.
- Use of other media may result in explosive media which may cause injury or damage.

Typical Setup



1. Fit Logs A and B. Log A positively locates onto the left-hand burner set. Log B positively locates onto the right-hand burner set.
Fill the ring burner cavity with clear pebbles. Make sure no clear pebbles are placed on top of the firing ports.

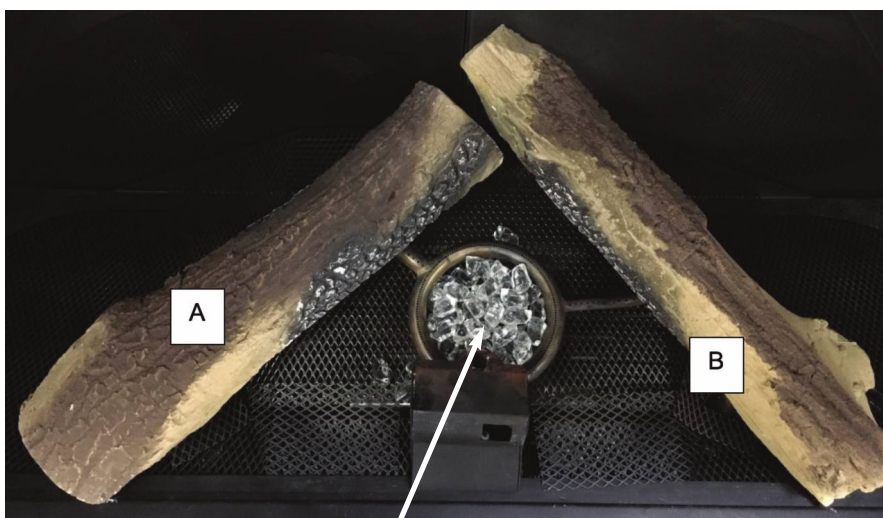

Clear pebbles

MEDIA SET UP (continued)

Spread clear pebbles over the mesh. Make sure no clear pebbles are placed on top of the firing ports.



Ensure no pebbles obstruct the firing ports

MEDIA SET UP (continued)

- Place Logs C and E as per the fix arrangement shown in the image below.

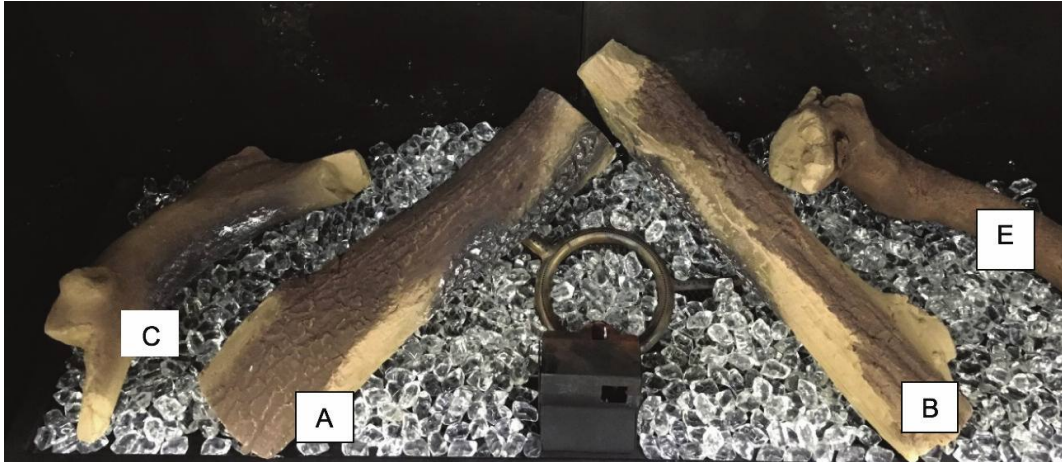

- Spread ceramic coals over the clear pebbles. Avoid smothering the firing ports.



- Place logs D, F, G, H and I as per the fix arrangement shown in the image below.

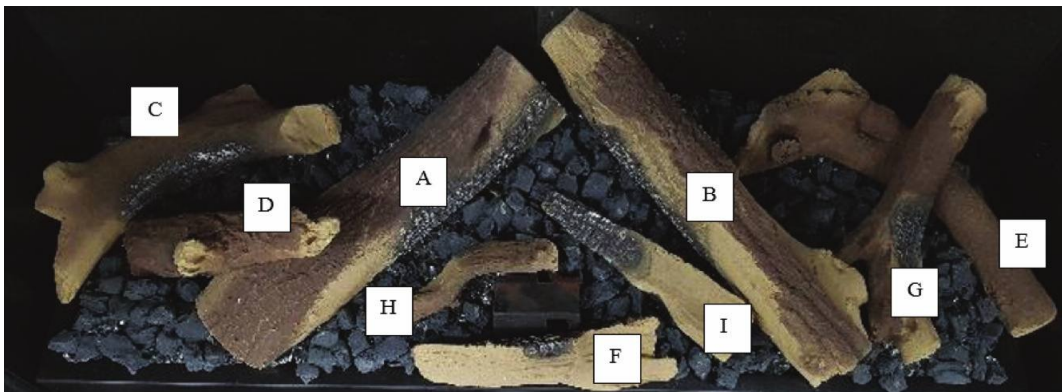

LED LIGHTING

Media back lighting using LED is available as a factory option (NOTE – Must be placed at time of ordering the appliance)

A different version of the remote control and receiver unit is used for the LED option.

The LED lighting systems include.

- 6 LED boards
- 6 LED linking cable 24AWG
- 1 LED Driver
- 1 240/24V Transformer

Accessing the LED module

- Remove fixing bracket
- Remove glass lid (make sure silicone gasket is fitted correctly)
- Access LED tray. (6 LED modules fitted on tray connected by linking cable 24AWG)

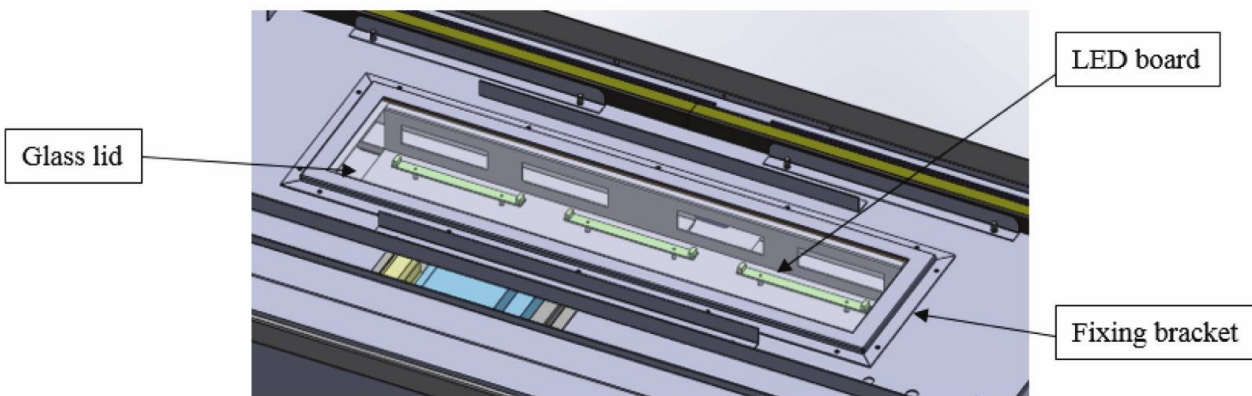

LED lights & Linking cable



LED driver



LED transformer

OPERATION – USER INSTRUCTIONS

- Do not operate if you smell gas. Turn appliance off, extinguish any open flame. Contact your installer or a licensed gasfitter.
- Do not use if any part of this appliance has been submerged in water. Contact your installer or a qualified service technician.
- Solid fuels must not be burnt in the fire. Leaves, sticks, wood, paper food or material must be kept away from the fire.
- Appliance operates with luminous flames, carbon deposits may occur during operation.

Should the appliance fail to ignite or was recently turned off, allow 5 minutes before attempting to reignite appliance.

In the event of abnormal operation please contact your licensed gas installer, gas service personnel or Glen Dimplex Pty Ltd. Abnormal operation may consist of the following, noisy fan, excessive, uneven or small flame, unusual flame appearance or colour, excessive sooting, explosive ignition or operation or other.

Appliance Quick Operation

1. Press power button on  the remote.
2. Press mode button until manual appears on lower area of screen
3. Press arrow up or down to change temperature.
4. Set the desired temperature - it must be above the room temperature for the appliance to operate.
5. Appliance will start once the flame symbol appears on the remote.
6. Appliance will perform a 40 second pre-purge, then sparking will occur. – Fire should operate within 1 minute of remote calling for heat.

NOTE – should the fire not start, a 5minute post purge will occur , turn off remote -wait 5 minutes before reattempting to light the fire.

REMOTE CONTROL OPERATING GUIDE



The Vektor is controlled completely by the use of the remote control; this remote can be used either as a manual operation or an auto operation.

- The remote thermostat uses radio frequency to transmit to the gas/fan controller.
- The remote thermostat has a LCD display
- The remote thermostat uses 2 off “AA” batteries which should last for 12 months. (Depending on quality of battery.) Batteries should be changed when smoke alarms are changed.
- The remote control and the controller are non-serviceable parts and if faulty should be returned to Real Flame Pty Ltd for replacement.

Locating the remote

The remote houses the thermostat that controls the heat output of the fire. When storing the remote either on its wall bracket or by placing it somewhere in the room where the fire is located, ensure there are no other heat sources that will affect the thermostats ability to accurately read the room temperature. For example, by placing the remote in direct sunlight or under a cushion, the fire may turn down or off before the room reaches the set temperature.

Factory Set Features

- When turned on the fire will always start on the low setting and remain on low for 3 minutes, it will then go to the high setting.
- The fan will automatically come on in the high mode after the fire has been operating for 3 minutes 20 seconds.
- When the fire shuts off on auto mode or is shut off in manual mode, the fan will continue to operate for 3 minutes in the “High” mode.
- The fire can be operated in either “Auto” mode or “Manual” mode.

Quick Start Guide

On/Off

Press and release the  button to turn the thermostat on and off.

Setting the day of the week and time

With the thermostat off, press and hold the ‘T’ button for 2 seconds or longer to initiate programming the time. Time, the hour setting and AM/PM will flash.

Setting the hour function

Press and release the ▲ or ▼ button to increase or decrease the hour setting by 1 hour.

Press ‘OK’ to accept.

Setting the minute function

Press and release, or press and hold the ▲ or ▼ button to increase or decrease the minute setting by 1 minute.

Press ‘OK’ to accept.

Setting the day of the week function

Press and release the ▲ or ▼ button to change the day of the week to the following or previous day. Press and hold the ▲ or ▼ button for 2 seconds or longer to increase or decrease the day of the week by 1 day every 0.5 seconds.

Press ‘OK’ to complete setting.

REMOTE CONTROL OPERATING GUIDE (continued)

Manual mode

Manual mode does not require that the time and day of the week are set.

Press the ▲ or ▼ button to increase or decrease the temperature desired.

Automatic mode

The automatic mode allows the temperature to be regulated according to a programmed level and time.

Manually overriding the set program

At any time, the temperature may be adjusted up or down. However, whenever the thermostat changes to a new time period, the temperature will be set automatically according to that period's setting.

Programming

Each day of the week can be programmed individually for 4 periods P1, P2, P3 and P4, making a total of 28 programmed periods.

Alternatively, a weekday program can be set, so the same program is used for Monday-Friday. Similarly, a weekend program can be set for Saturday-Sunday. The entire week can also have the same program.

Alternatively, a weekday or weekend program can be set with individual programs for the remaining days.

The suggested period settings for each day/s are:

- Period 1 - morning
- Period 2 - daytime
- Period 3 - evening
- Period 4 - night-time

To begin programming

With the thermostat off, press and hold the 'P' button for 2 seconds or longer to initiate programming. The LCD will display **PROG**, *Pd* and the time at which the thermostat is currently set. **MO** will flash.

Period 1 can now be set.

- *Setting the day of the week*

You must choose which day/s of the week you wish to program.

Press and release the ▲ or ▼ button to change the day of the week to the following or previous day. Press and hold the ▲ or ▼ button for 2 seconds or longer to increase or decrease the day of the week by 1 day every 0.5 seconds.

The order that you can scroll through the days is as follows:

MO → TU → WE → TH → FR → MO TU WE TH FR → SA → SU → SU SA → MO TU WE TH FR SA SU

To accept the selected day/s of the week press 'OK'.

REMOTE CONTROL OPERATING GUIDE (continued)

Programming

- *Setting the period starting time*

The hour and AM/PM settings will now flash. To set the P1 starting time, press and release the ▲ or ▼ button to increase or decrease the hour setting. Press and hold the ▲ or ▼ button for 2 seconds or longer to increase or decrease the hour setting by 1 hour every 0.5 seconds.

Please ensure that AM/PM is set correctly.

Press 'OK' to accept.

The minute setting will now flash. Adjust the minute setting similarly, using ▲ or ▼ button

Press 'OK' to accept.

- *Setting the temperature*

The temperature setting will now flash. Press and release the ▲ or ▼ button to increase or decrease the temperature setting by 1 °C. Press and hold the ▲ or ▼ button for 2 seconds or longer to increase or decrease the temperature setting by 1°C every 0.5 seconds.

Press 'OK' to accept.

Period 1 is now set for the day/s of the week that you have chosen. The LCD will display **P2** to indicate that Period 2 can now be set for the same day/s of the week.

Repeat the programming process for periods 3 and 4.

After program 4 is set, press 'OK' and the program for the selected day/s will be set.

Repeat the programming process for any other periods/days that are required.

Restore factory default settings

With the thermostat off, press the following sequence of buttons: 'P', 'T', 'T' ▼.

Teaching RF thermostat ID code to control unit

CAUTION: The thermostat has already been programmed with a unique code. Do not attempt to teach the RF Thermostat ID code unless instructed by the manufacturer.

With the thermostat off, press the following sequence of buttons: 'P', 'T', 'T' ▲.

The LCD display will show 'CL' (Code Learn) for 2 seconds then return to the normal OFF state display. During this time a special code will be transmitted by the RF Thermostat to the Control Unit, causing the Control Unit to learn its ID.

WARNING

When the RF thermostat is in the "Auto" mode and the room temperature drops below the minimum temperature, the fire and fan will come on and operate until the room temperature is 3° above the minimum and then turn off, therefore:

- The minimum temperature should be set at a temperature that is not likely to cause the fire to continually turn on and off.
- If leaving the house for an extended period, the RF thermostat should be turned "OFF".
- As long as the RF thermostat is in the "Auto" mode and the temperature goes below the minimum set temperature, the fire will come on no matter what times are programmed into the thermostat.
- If you are unsure of the operation of the RF thermostat, please contact the manufacturer.
- In the event of loss of power, the appliance will shut down safely. The appliance may automatically resume operation once power is restored, pending the operation mode of the remote control.

WIFI DEVICE CONTROL INSTRUCTIONS

Wifi control is available on the Vektor space heater.

Wifi control offers a temperature feature which can be used in conjunction with the supplied remote control or as the independent control.

Multiple devices can control the appliance. The appliance will operate based on its last received command.

Note 1 – Multiple devices may be connected to the appliance, only one appliance can be controlled by a device at a time.

Note 2 – The room air temperature sensing device is located in the remote, accuracy of the temperature sensing may be effected by the room layout, appliance installation and nearby furniture.

Note: The programming function is only done via the remote control.

Introduction

These pages outline the Operation of the Real Flame MKII Thermostat system. The System Includes

1. Real Flame Modulating Valve MKII update
2. Real Flame WiFi Interface MKII
3. Real Flame Thermostat MKII App
4. Real Flame MKII Web Service

These instructions assume that the Modulating valve has been installed into a fireplace with the WiFi module connected.

WiFi Set-up

From Factory settings the Fireplace will broadcast an Access Point for the Mobile App to join with, the Access point names have the following format,

Realflame_XXXXXX

Where 'XXXXXX' is the last six digits of the WiFi modules MAC addresses, the Access point is secured with the default password 'Realflame'

Joining the access point in this mode will allow you to,

1. Control the Fireplace via its own WiFi Access point, and is good for Demo and testing functionality
2. Push the Fireplace to a local or home network, this allows you to control the Fireplace whilst also being able to use your local network resource such as Internet, email and Facebook.
1. This mode is required to utilise the Server control features of the Fireplace.

WIFI DEVICE CONTROL INSTRUCTIONS (continued)

Step by Step – Pushing the Fireplace to a local network

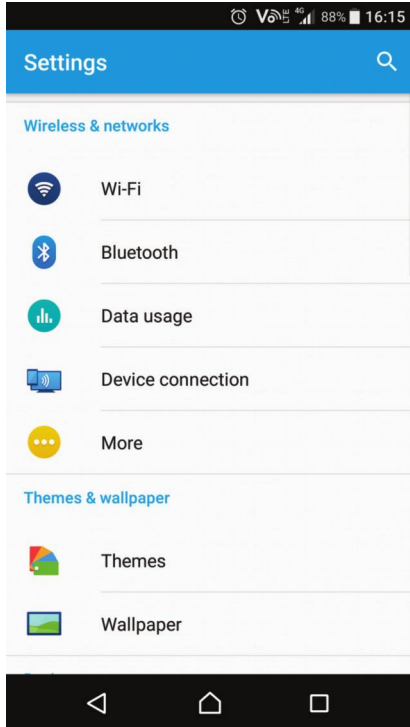

Illustration 1: Open up the settings Screen and select the Wi-Fi option

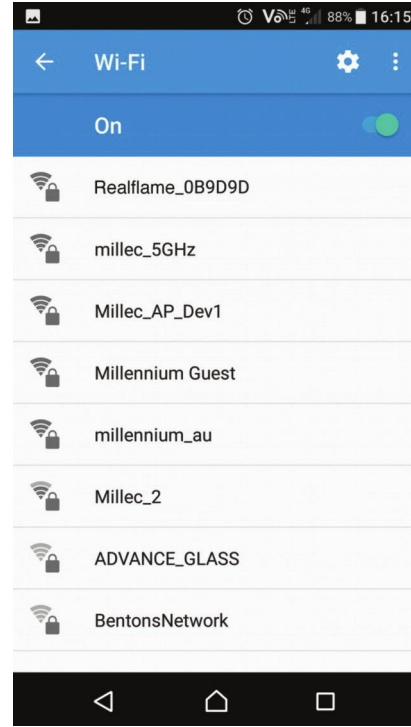

Illustration 2: Select the Access point for your Fireplace

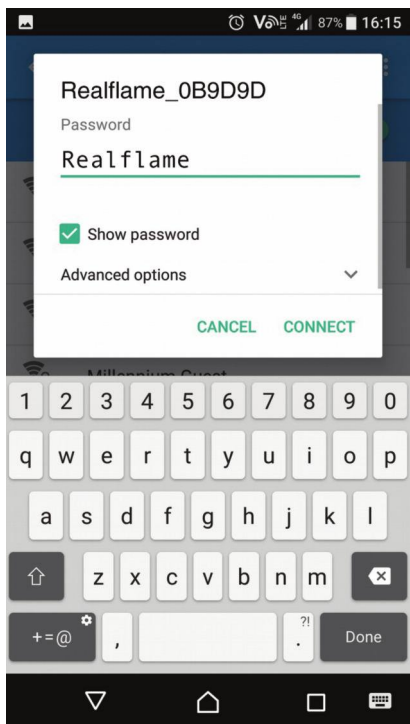

Illustration 3: Enter the default password for your Fireplace AP

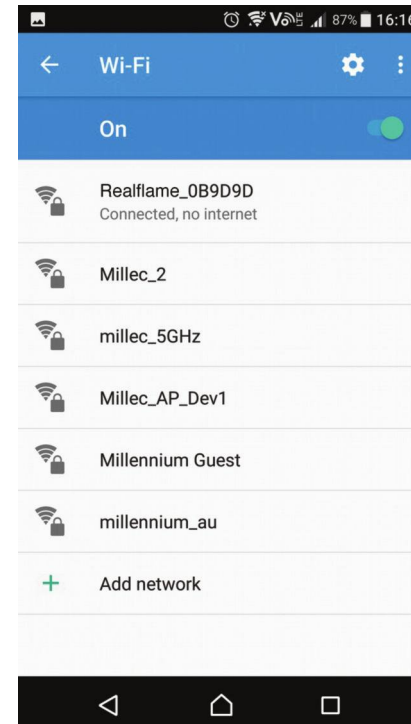

Illustration 4: Check the connection status for the Fireplace

WIFI DEVICE CONTROL INSTRUCTIONS (continued)

Step by Step – Pushing the Fireplace to a local network

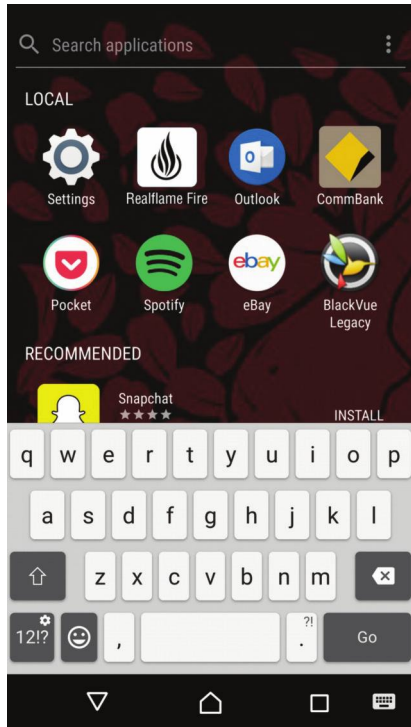

Illustration 5: Open the Fireplace App

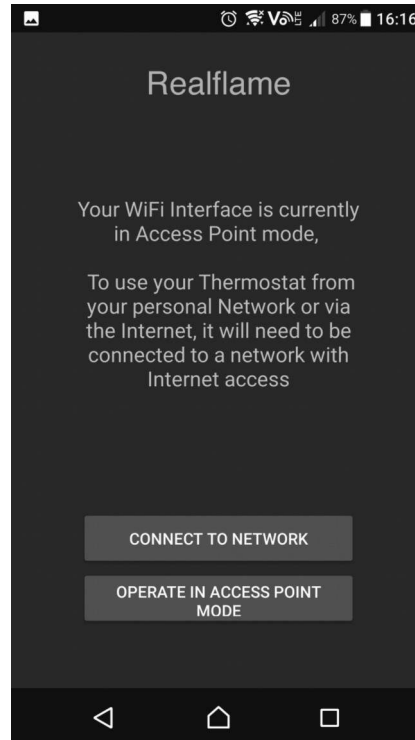

Illustration 6: When prompted, select 'Connect to Network'

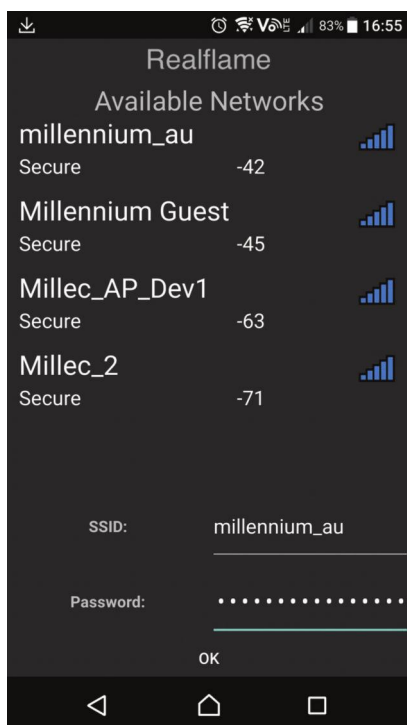

Illustration 7: Select the Network you want to use

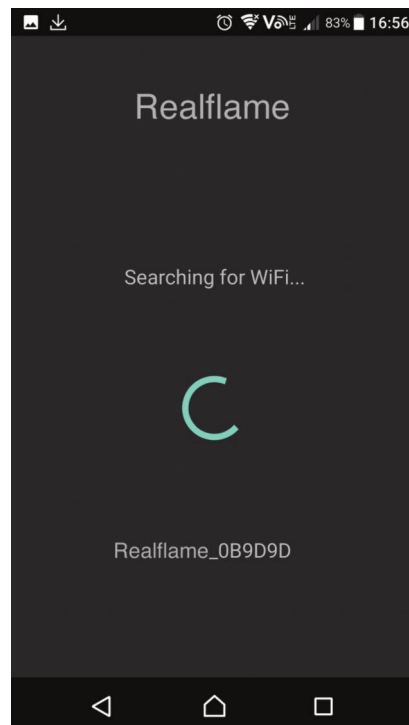

Illustration 8: The App will start to search for the device on the network

WIFI DEVICE CONTROL INSTRUCTIONS (continued)

Step by Step – Pushing the Fireplace to a local network

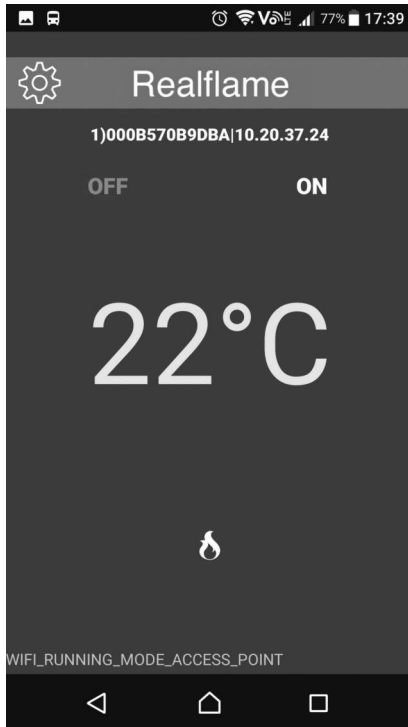

Illustration 9: You can now control your Fireplace from the network you are connected to.

WIFI DEVICE CONTROL INSTRUCTIONS (continued)

Internet Control

If your model supports Internet control, upon using the App after being pushed to a local or home network with internet, the application will prompt you to set up the network features.

Set-up

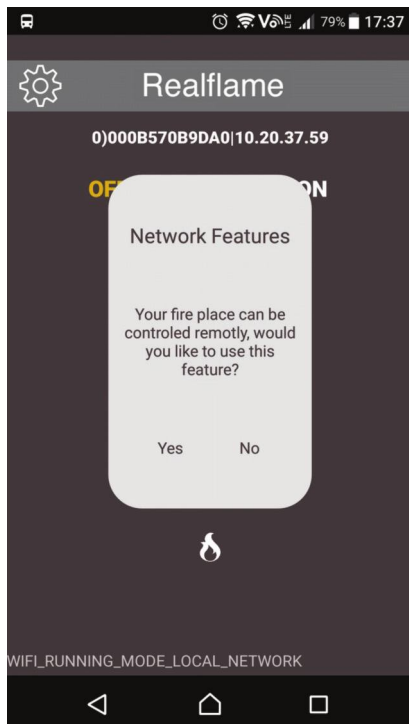

Selecting Yes will take you to the sign up screen

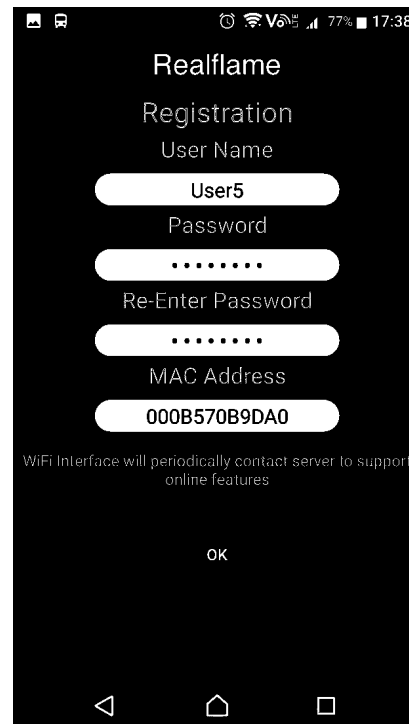

Registration requires:

- A user name
- Password
- - Details of the connecting device; these will be pre-filled for you

WIFI DEVICE CONTROL INSTRUCTIONS (continued)

Step by Step – Pushing the Fireplace to a local network

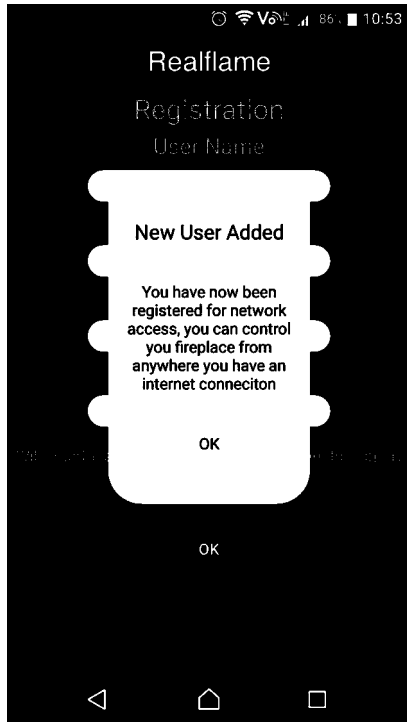

User Added Successfully, your Fireplace is now linked to your account, you can control your Fireplace by logging into the application when prompted

Operation

When on another network or using your Mobile data, launching the App will present you with the log in screen.

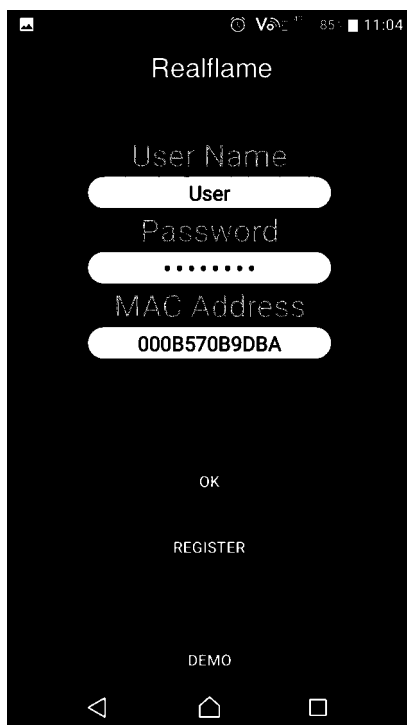

Illustration 10: Enter Your Details to access the web control

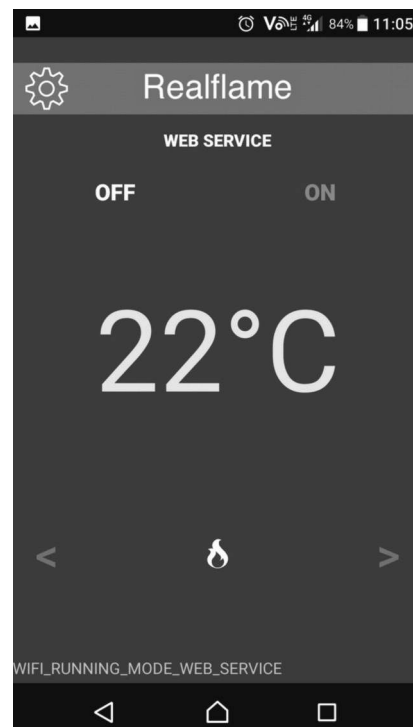

Illustration 11: After a successful login, you will have control of you Fireplace

WIFI DEVICE CONTROL INSTRUCTIONS (continued)

Pushing the Fireplace to a different home or local network after initial install

Pushing the Fireplace to a different home or local network after it has previously been set up, is done at Fireplace power on, when the fireplace is powered off at the Main switch, upon being powered on, the Fireplace will show its Access point (Realflame_XXXXXX) for 30 seconds.

If you join the access point with your mobile device, you will be able to change the network the Fireplace is currently connected with via the mobile App.

If you do not join the Access point the Fireplace will join the network that it has settings saved for or if there are no settings, it will stay in Access Point mode.

Note: If you join the access point by accident on power on, you can simply power off the Fireplace and power on again, after the 30 seconds the Fireplace will join the network with its saved settings

Note: If not connected to wifi you can still control the fire via 4G or 5G network.

AUTO MODE - Only available via the remote.

TROUBLESHOOTING

Problem	Possible Cause	Suggested Remedy
When the remote is activated nothing happens	The remote is not talking to the receiver.	Reprogramme the remote to the receiver (Refer Millennium manual in installation manual).
	The remote batteries are flat.	Replace the batteries.
The fire cuts off and won't relight	The over temp snap disc has been activated.	Allow the fire to cool down and then try to relight the fire. If the fire fails to relight, contact the manufacturer.
The fan will not come on	Possible caused by overheat or electrical fault.	Contact the manufacturer.
Flame appears to be low	Pressure not set.	All pressures are set in the factory at the time of manufacture, however the installing plumber mus make sure the pressures are correct.

IF YOUR FIREPLACE STILL DOES NOT OPERATE CORRECTLY CONSULT YOUR DEALER.

ALL SERVICE AND REPAIRS SHOULD BE PERFORMED BY AN AUTHORISED AGENCY.

ALL SPARE PARTS AND OPTIONAL TRIM FINISHES ARE AVAILABLE FROM REAL FLAME PTY LTD.

BURNER PRESSURE ADJUSTMENT

Burner test point pressures must be set whilst appliance is running.

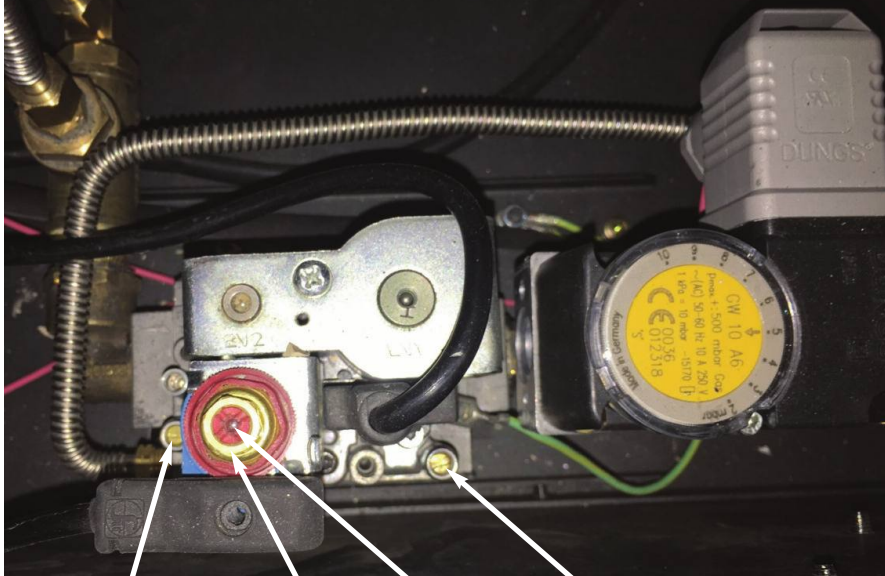

Outlet test point pressure Max pressure adjustment nut Low pressure adjustment screw Inlet gas pressure test point

1. Turn appliance off at remote control.
2. Remove outer glass safety screen
3. Remove lower cover
4. Remove electrical cover
5. Loosen burner pressure test point screw and fit manometer to barb.
6. Turn on appliance and set remote control at least 3 deg C above room temperature. Heater will run on low (minimum) burner pressure for 3 minutes then automatically increase to high rate.
7. After 3 minutes heater defaults to high speed (ensure remote control is showing maximum flame)
- Using 10mm spanner or similar adjust maximum gas rate by turning outer brass nut to the correct test point pressure kPa.
8. Turn appliance down to minimum rate using remote control (adjust setpoint temperature to be 1deg lower than the room temperature).
9. While remote is set to low flame - Using Phillips or small flat screwdriver, adjust minimum pressure to the correct test point pressure kPa by turning red plastic screw.
10. Turn appliance up to maximum rate using remote control (adjust setpoint temperature to be 3deg or more than the room temperature). Check maximum test point pressure, adjust if required.
11. Turn appliance down to minimum rate using remote control (adjust setpoint temperature to be 3deg or more than the room temperature). Check test point pressure, adjust if required.
12. Confirm maximum and minimum pressures are correct.
13. Turn appliance off at remote control.
14. Remove manometer and tighten test point screw.
15. Start appliance and check test point for gas leaks where necessary.
16. Refit panels.
17. Refit safety glass screen.

WIRING DIAGRAM

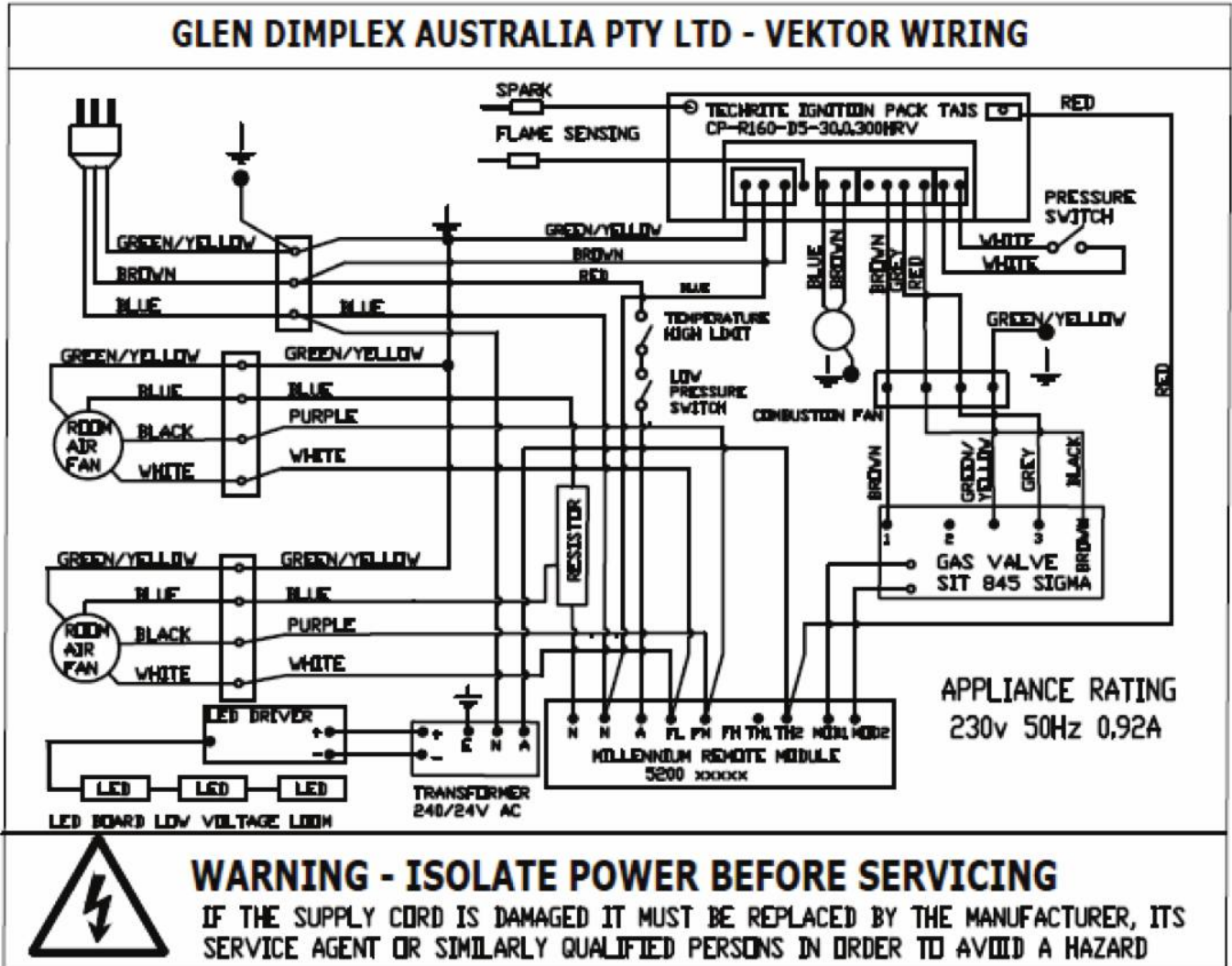

INJECTOR AND PILOT REMOVAL INSTRUCTIONS

Appliance supplied as Natural Gas only

TOOLS

- 10mm spanner
- 15mm spanner
- 16mm Spanner (recommended) or small/medium shifter
- No2 Phillip head screwdriver
- Allen key 2.5mmAF

BURNER

1. Turn appliance off and allow to cool.
2. Turn off gas to appliance.
3. Turn off and isolate appliance from electrical supply.
4. Remove primary glass guard, then remove lower cover and remove electrical cover.
5. Remove door retaining screws and remove door.
6. Remove media where fitted. Carefully not to damage or break logs. It is recommended a dust mask is worn.
7. Remove burner media support tray
8. Remove burner fixing screws (2 off at front of burner).
9. Undo gas connections from bulkhead nuts (2 off) at RH end of burner. (14mm and 16mm spanner required for burner pipes).
10. Undo pilot gas connections from bulkhead nut (1 off) at RH end of burner. (13mm and 15mm spanner required for pilot pipe).

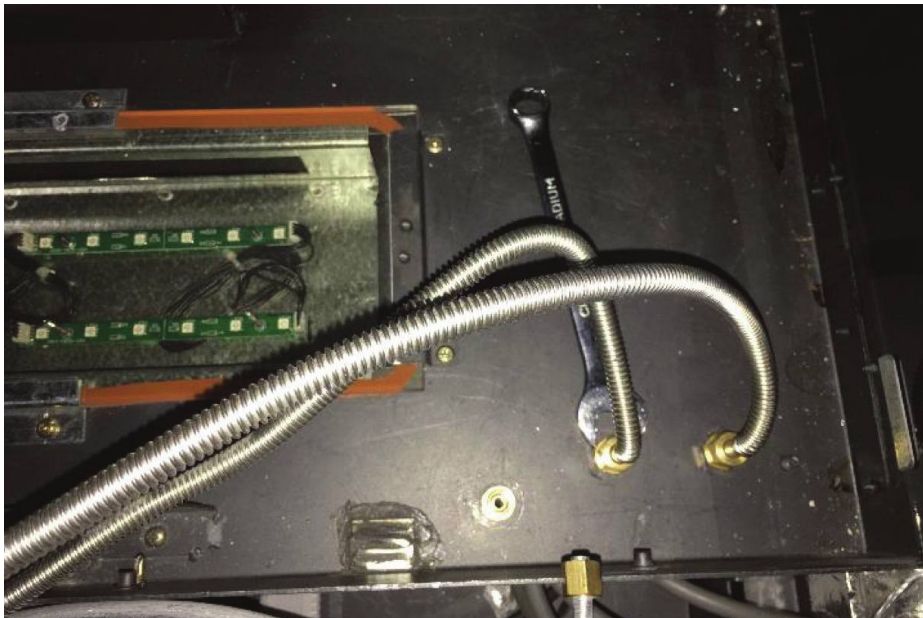

11. Lift burner up and gently support.
12. Remove pilot cover.
13. Remove spark lead from pilot assembly.
14. Remove flame sensing lead from pilot assembly.

INJECTOR AND PILOT REMOVAL INSTRUCTIONS (continued)

15. Lift burner out gently.
16. Loosen burner nuts located at the bottom of the burner.

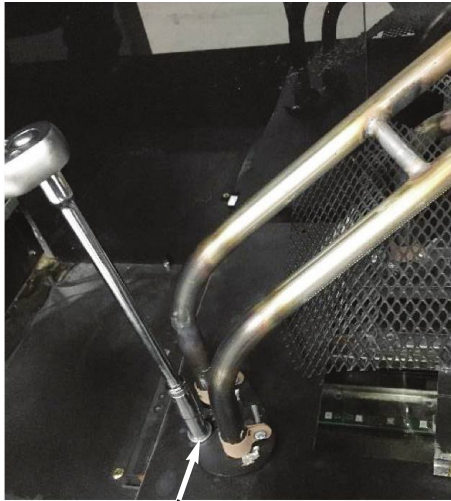

Left hand burner tubes



Right hand burner tubes



Back burner tubes

17. Remove burner tube assembly.



18. Remove injectors from burner manifold.
19. When refitting injectors, a high pressure gas thread sealant must be used.
DO NOT OVERTIGHTEN THREADS. (Check for leaks once the injectors are installed)

INJECTOR AND PILOT REMOVAL INSTRUCTIONS (continued)

Apply thread sealant to injector threads. Ensure no sealant can block the injector. Fit injectors and tighten. NOTE INJECTOR SIZE AND LOCATION.

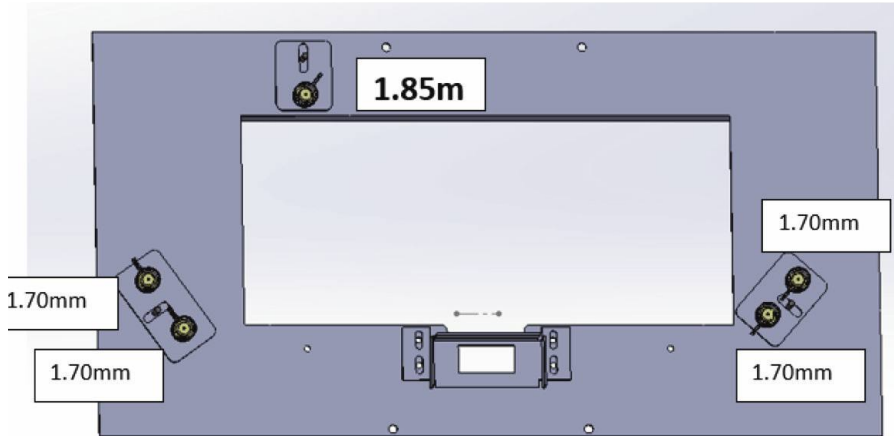

20. PILOT

- Remove pilot gas pipe connection,
- Remove sensor lead and spark lead (10mm spanner required)
- Unscrew pilot bracket from the burner base.

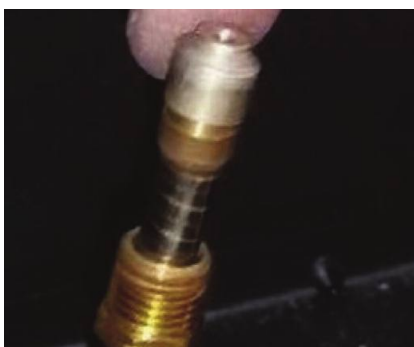
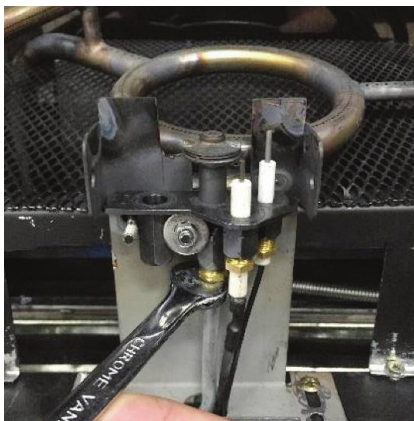

21. Remove pilot orifice from pilot or replace whole pilot assembly with correct gas type.

INJECTOR AND PILOT REMOVAL INSTRUCTIONS (continued)

22. PILOT REFITMENT

Replace pilot orifice with correct gas type.

Refit pilot gas pipe to pilot assembly and tighten.

Place burner assembly into appliance.

Refit spark probe and gently tightly

Refit spark lead

Locate pilot assembly onto original position and refit the bracket retaining screws.

Note: Check all wires are sitting correctly, flush to front wall. Ensure spark lead is not broken or excessively bent. Ensure lead hole is still sealed.

(High temperature silicon is suitable for resealing.)

23. BURNER REFITMENT

Carefully place burner into firebox, screwing burner plate onto burner bracket.

Tighten gas and pilot pipe connections to the bulkhead fittings located at the bottom of the firebox.

Ensure 2 spanners of correct size are used to prevent loosening of bulkhead nut.

Refit burner tube assembly, Tighten nuts (3 off)

Check burner location to pilot.

Pilot location to burner. – Burner should sit within 2mm of the pilot bracket. Burner must sit on the pilot bracket support. Adjust if required.

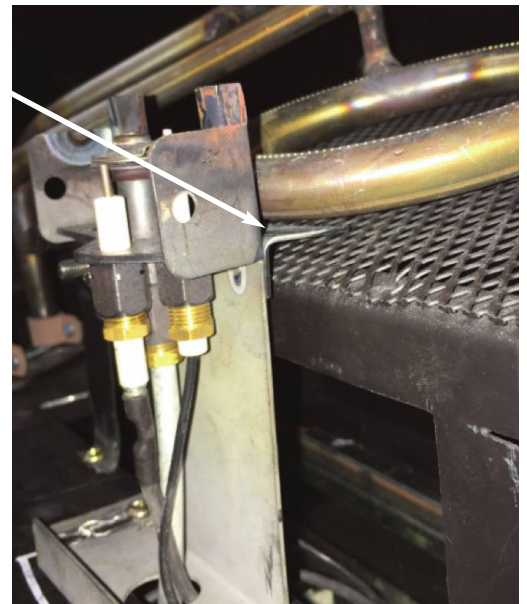
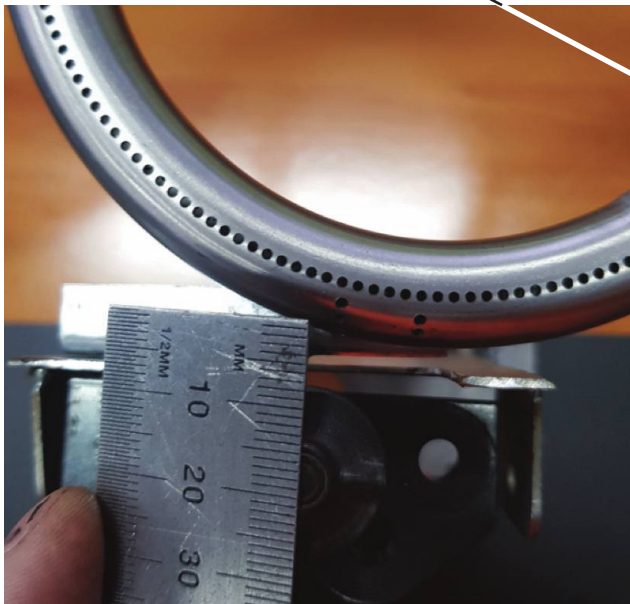

Refit Media support tray (Mesh).

INJECTOR AND PILOT REMOVAL INSTRUCTIONS (continued)

Replace media as per media fitment Instructions.

Refit door. Check door seal is sitting correctly. Fit screws to seal

DO NOT OVERTIGHTEN SCREWS – Hand tight is sufficient for door to seal.

Turn gas isolation valve off.

Turn on electrical supply.

Turn on appliance and perform dry test run, allow appliance to spark, check for correct sparking location and frequency.

Turn off appliance.

Turn on gas isolation valve.

Turn appliance on and allow appliance to ignite.

Check gas pressures.

Check for gas leaks.

Check for correct operation, cross ignition of burners and flame. After 10minutes check flame color. Flame should be blue with yellow tipping, Tall blue or fully yellow flames indicate incorrect burner setup. Cross ignition should be smooth with no “woofing” or explosive delays.

SHOULD THE APPLIANCE NOT OPERATE CORRECTLY - TURN APPLIANCE OFF, ISOLATE GAS AND ELECTRICITY SUPPLY AND CONTACT GLEN DIMPLEX SERVICE.

Turn off appliance.

Disconnect manometer and tighten close test point.

Check for any gas leaks.

Refit lower electrical cover.

Refit lower panel.

Refit glass safety screen. (Note 2 persons required).

Advise customer on correct operation and isolation of appliance in the event of a fault.

PARTS LIST

1. SIT 845 Sigma Gas Valve
2. SIT Pilot assembly Natural gas
3. Injector Natural gas 1.75mm / 1.85mm – injector is stamped on side of body
4. Millennium receiver
5. Millennium remote control
6. Techrite Ignition pack / gas control

